I N S T R U C T I O N M A N U A L
F O R

V I B R A T I N G L E V E L S E N S O R



M O D E L : V P 1 1



Issued 2007-06-25

Read and understand this manual for safely usage.

- This manual describes the product of standard specification. Read the other manual for the product of explosion-proof specification.
- This manual describes the handling, inspection and adjustment of the product which model is mentioned on cover page. Read and understand this manual before handling.
- Follow the additional document and/or direction, submitted by NOHKEN INC. and our distributor or agent, even if the terms are mentioned in this manual.
- Save this manual in proper place being available to refer immediately.
- The specification of product mentioned in this manual may not be satisfied by the condition of environment and usage. Check and consider carefully before using.
- Contact to sales office at NOHKEN INC. for any question or comment about this manual and product.

The followings are the description of the terms in this manual.

 WARNING	Indicates a potentially hazardous situation which, if not pay attention, could result in death, serious injury or serious disaster.
 CAUTION	Indicates a hazardous situation which, if not pay attention, may result in minor or moderate injury or damage to device.

	Indicates prohibited matter. The explanation with this mark shall be followed.
	Indicates instructed matter. The explanation with this mark shall be followed.



WARNING

• This product is not explosion-proof construction. Do not install this product to the place where the flammable gas or vapor is occurred. If installed, the flammable gas or vapor may be ignited, and serious disaster may be occurred. Use the product of explosion-proof construction in this case.



• Do not modify or disassemble the product. Otherwise, the product and connected device may be malfunctioned, damaged, fired, or miner injury and electric shock may be occurred. (Follow the additional document and/or direction, submitted by NOHKEN INC. and our distributor or agent.)



• Turn off the power, before wiring and inspection. Otherwise, electric leakage, fire caused by short circuit, and electric shock may be occurred.



• Ensure the wire is properly connected. The product and connected device may be malfunctioned, damaged, fired, or miner injury and electric shock may be occurred by improper wiring.



• Turn off the power immediately, if the smoke, strange smell and sound are occurred.
Do not use it until the problem is solved.



CAUTION

• Avoid strong shock and rough handling to this product. The product may be damaged by strong shock as dropping, falling, throwing, knocking, lugging, and etc.



• Follow the specification of operating temperature, operating pressure, switch rating, and etc. Otherwise, the product and connected device may be malfunctioned, damaged, fired, or miner injury and electric shock may be occurred. Check the manual or specification sheet.



• Operation test shall be done before practical usage. If the serious accident is expected to occur by malfunction of product, the other operating principle of product shall be installed in parallel.



—  CAUTION —

• Check and deeply consider the chemical compatibility for material of product in advance.



• Provide arrester or surge absorber to avoid electrical impact such as lightning and static electricity. If not provide, the product and connected device May be malfunctioned, damaged, and fired, or miner injury and electric shock may be occurred.



INTRODUCTION

- A) This manual specifies the specification of general product. If you order special product, some details of specification may be different with the manual.
- B) We are glad to suggest and advice for Model selection and chemical resistant of material, but final decision has to be made by the customer.
- C) This manual has prepared with close attention. Ask sales office at NOHKEN INC. for any question or comment about the contents of this manual.
- D) For replacement parts
The quality of product has frequently improved, so same spare part may not be supplied. In this case, replacement part or product may be supplied. Ask sales office at NOHKEN INC. for details.
- E) The contents of this manual are subject to change any time without notice due to the improvement of product.

TABLE OF CONTENTS

	PAGE
TABLE OF CONTENTS	1
1. WARRANTY & DISCLAIMER	2
2. PURPOSE OF USE	2
3. DESCRIPTION	2
3.1 Description	2
3.2 Principle of operation	2
3.3 Nomenclature	3
4. SPECIFICATIONS	4
4.1 Measuring object	4
4.2 Operation characteristics	4
4.3 Electrical characteristics	4
4.4 Mechanical characteristics	4
4.5 Environment	4
4.6 Construction	4
4.7 Physical	4
5. HANDLING NOTES	5
6. INSTALLATION	6
6.1 Unpacking	6
6.2 Installation	7
6.2.1 Location	7
6.2.2 Mounting	8
7. WIRING	9
7.1 Preparation	9
7.2 Wiring	9
8. ADJUSTMENT METHOD	10
9. MAINTENANCE & INSPECTION	10
9.1 Removing	10
9.2 Maintenance & Inspection	11
9.3 Re-installation	11
9.4 Wiring	11
9.5 Adjustment method	11
10. STORAGE	11
11. TROUBLESHOOTING	12
12. GLOSSARY	13

1. WARRANTY & DISCLAIMER

- A. Nohken Inc. warrants this product against defects in design, material and workmanship for a period of one (1) year from the date of original factory shipment.
- B. If defects occurs during the above-mentioned warranty period, Nohken will, at its option, replace or recondition the product without charge. This shall constitute the exclusive remedy for breach of warranty.
- C. Nohken Inc. makes no warranty with respect to:
 - C-a Failure not to comply with instructions of this manual.
 - C-b Failure or damage due to improper installation, wiring, operation, maintenance, inspection and storing.
 - C-c Product which has been in any way repaired, altered or tampered with by others.
 - C-d Product repaired or modified by using undesignated parts, subassemblies and materials.
 - C-e Direct incidental or consequential damages or losses or expenses resulting from any defective product or the use of any product.
 - C-f Inevitable accident such as acts of God, force majeure, radioactive contamination and so on.

THIS WARRANTY IS IN LIEU OF AND EXCLUDES ALL OTHER WARRANTIES OF MERCHANTABILITY OR FITNESS FOR A PARTICULAR PURPOSE.

2. PURPOSE OF USE

The vibrating level sensor, model VP is used for level detection of resin powders, pellets and so on. It is used for taking out the control signal from alarms or the relay. Do not use in any other applications.

3. DESCRIPTION

3. 1 DESCRIPTION

The VP detects solids by installing the vibrating part inside the hopper. Since it is compact and has no moving parts, the VP is ideal for use in small hoppers and/or OEM equipment. The sensor incorporates a sensitivity adjuster that allows optimum sensitivity adjustments according to the type of sensing material or the degree of contact with the sensing material.

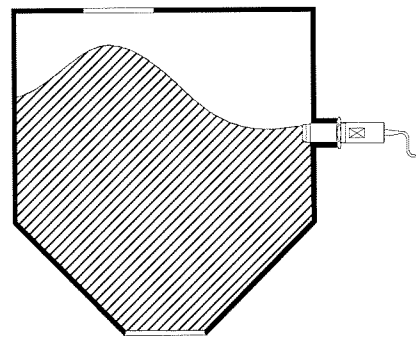

3. 2 PRINCIPLE OF OPERATION

The piezoelectric element(*) generates vibration to the vibration diaphragm(*) so that the ringing occurs. The ringing converges smoothly when contacting with solids and quickly when not contacting with the solids. The VP compares the way of ringing convergence and detects the solids.

* : See section 12 for the word explanation.

3. 3 NOMENCLATURE

①VIBRATION DIAPHRAGM

Vibrating detection part which contacts with solids.

②FIXING NUT (With washer and gasket)

To fix the sensor completely to the hopper.

③BODY

Built-in electric circuit and so on.

④VOLUME CAPS

The volume caps is used to seal the sensitivity adjuster(volume) hole.

⑤OUTPUT CABLE (PVC sheathed)

φ3 × 2000 mm (3 × 0.2 mm²), PVC

⑥POWER · OPERATION LED

Green : Lights when power is supplied.

Red : Lights when detecting solids.

Orange :Both red and green indicators will turn on, thus emitting orange light if there is a reset delay

⑦SENSITIVITY ADJUSTER

A volume to make sensitivity adjustments according to the type of sensing material.

⑧SANITARY FITTING (equivalent ISO 1 1/2 S)

Used to mount the sensor with the sanitary fitting.

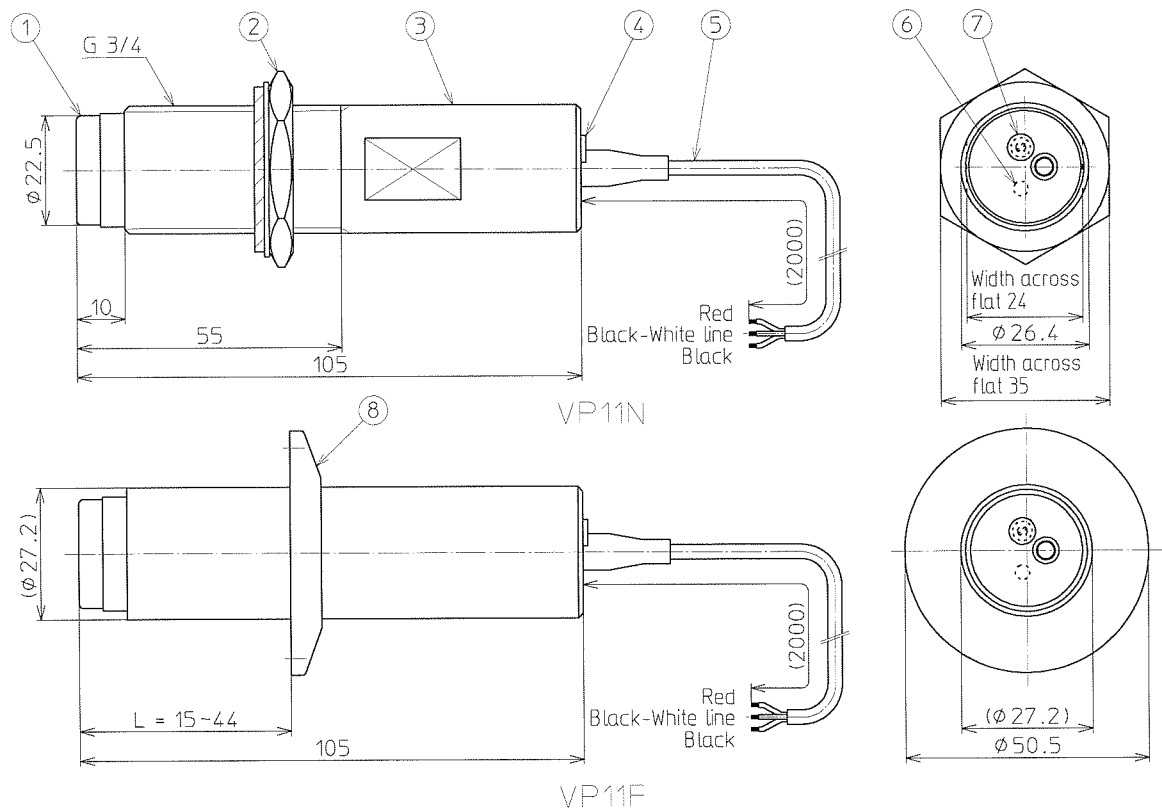

4. SPECIFICATIONS

4. 1 MEASURING OBJECT

Powder, Granular materials

(Varies with granular, but $\phi 5\text{mm}$ or less can be detected)

4. 2 OPERATION CHARACTERISTICS

①Sensitivity : Apparent specific gravity 0.2 Min.

②Operation indicator: LED lighting

Detection :Red

Non detection :Green

Delayed recovery :Orange

4. 3 ELECTRICAL CHARACTERISTICS

①Power supply : 24 V DC (18 to 30 V DC)

②Current consumption: 20 mA DC Max. (24 V DC)

③Alarm output : NPN Open collector(*)

(100 mA DC Max. Residual voltage ; 1 V Max.)

4. 4 MECHANICAL CHARACTERISTICS

①Withstand pressure : 500 kPa Max.

②Vibration proof : 10 to 55 Hz ± 0.75 mm (amplitude)

4. 5 ENVIRONMENT

①Working temperature: -10 to $+60$ $^{\circ}\text{C}$

②Working humidity : 5 to 95 %RH

4. 6 CONSTRUCTION

Drip-proof construction (Equivalent IP55)

4. 7 PHYSICAL

①Materials

Vibration diaphragm : 316 stainless steel

Body : 304 stainless steel

Cap : PC

Output cable : PVC

②Mounting VP11N : G 3/4 (Screw thread)

VP11F : Equivalent ISO 1 1/2 S (Sanitary fitting)

③Mass VP11N : Approx. 220 g

VP11F : Approx. 300 g

* : See section 12 for the word explanation.

5. HANDLING NOTES

Cautions shall be taken as follows. If not, the sensor shall be damaged.

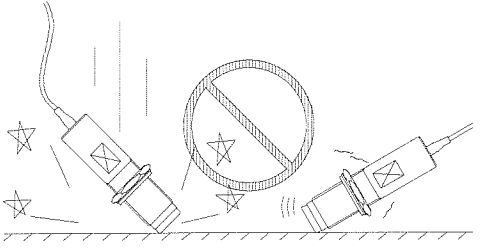
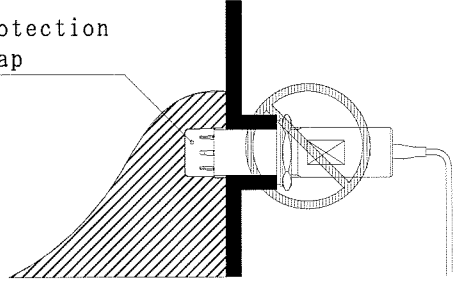
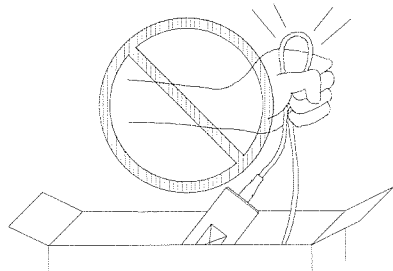
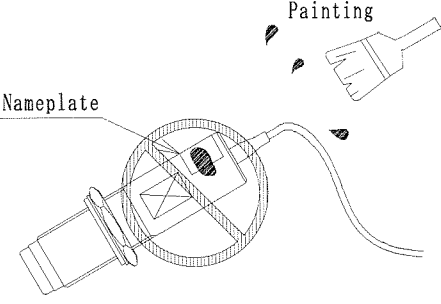
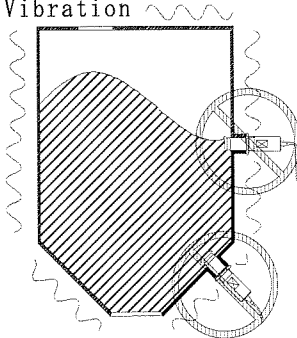
<p>5. 1 Avoid physical shock. Dropping, throwing or bumping shall damage the sensor.</p>	
<p>5. 2 Remove the protection cap when installing the sensor. Otherwise, the VP can not detect the solids.</p>	<p>Protection cap</p> 
<p>5. 3 Take out the sensor from the package carefully. Do not bend the cable strongly (Radius of curvature 25mm Min.). Otherwise, the cable may be broken.</p>	
<p>5. 4 When painting the sensor, keep the nameplate and the volume caps free of paint, otherwise the serial number may not be illegible and maintenance work on the sensor may be obstructed.</p>	<p>Painting</p> <p>Nameplate</p> 
<p>5. 5 Do not use or store where vibration occurs. If inevitable, provide appropriate means to prevent from vibration.</p>	<p>Vibration</p> 

6. INSTALLATION

6. 1 UNPACKING

6.1.1 Check the sensor exterior for damage. If there is, contact Nohken.

6.1.2 Do not remove the protection cap until installation.

6.1.3 Take out the sensor from the package carefully. Do not bend the cable strongly. Otherwise, the cable may be broken.

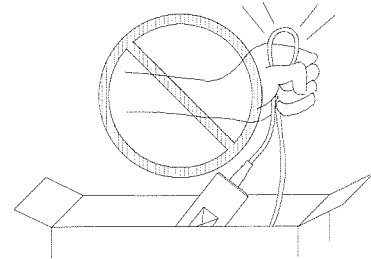

6.1.4 Avoid physical shock. Dropping, throwing or bumping shall damage the sensor.

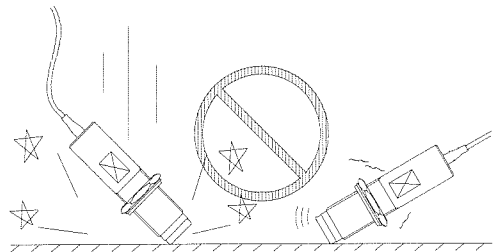

6.1.5 Do not put things on the sensor. It shall damage the body or nick the cable.

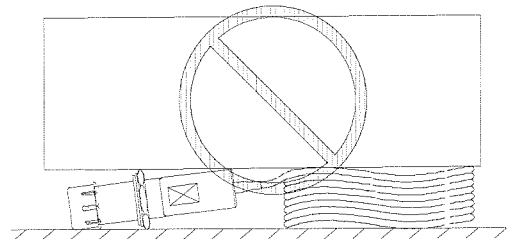

6.1.6 Model numbering of the sensor is indicated on the nameplate. Check it to be sure as required.

Nameplate

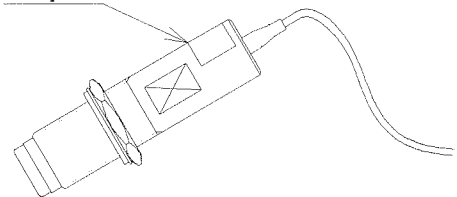

6. 2 I N S T A L L A T I O N

6.2.1 LOCATION

- (1) Pay attention to the angle of repose. (*)
Otherwise, the sensor may cause malfunction.

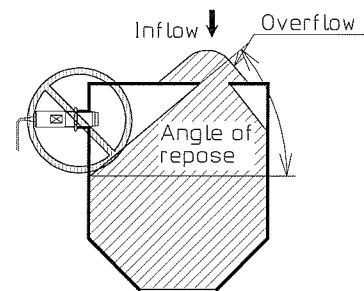

- (2) Pay attention to the dead stock. (*)
Otherwise, the sensor may cause malfunction.

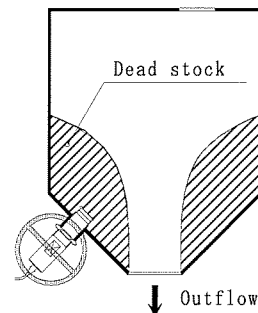

- (3) Pay attention to the bridge. (*)
Otherwise, the sensor may cause malfunction and damage the sensor when bridge fell.

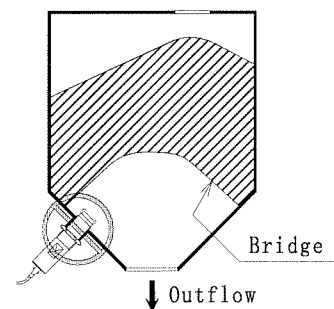

- (4) Keep the vibration diaphragm out of the direct flow. Install the guard above the VP if necessary.

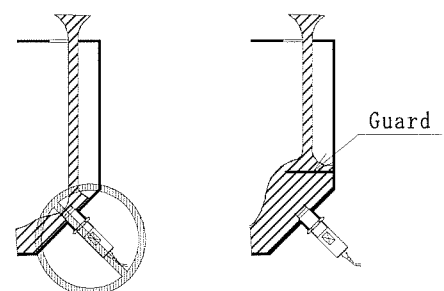

- (5) Do not install where vibration occurs.
Installing near vibrator(*) or knocker(*) will cause malfunction and damage the sensor.

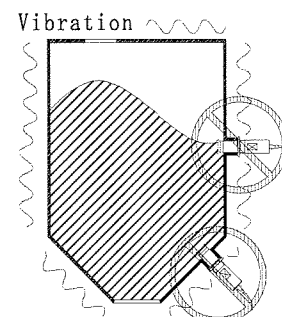

* : See section 12 for the word explanation.

- (6) Max. temperature range for the VP is 60°C.
Do not install where exceeds the temperature range.
- (7) Do not locate the sensor where exposed to direct sunlight. Install a sun shield (*) over the body if necessary.

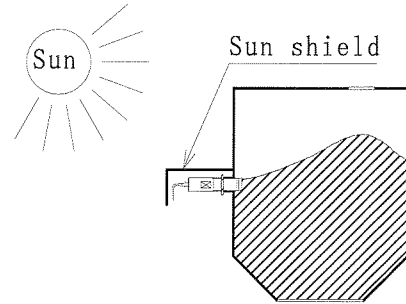

6.2.2 MOUNTING

- (1) SCREW-IN MOUNTING (VP11N)
Provide G3/4" female thread. Screw-in the screw part of the body and fix it with the nut.
- (2) BULKHEAD MOUNTING (VP11N)
Drill a $\phi 27\text{mm}$ hole. Insert and tighten the nut from both outside and inside the tank. One more nut (option) is needed.
- (3) MOUNTING SANITARY FITTING (VP11F)
Mount the sanitary fitting with the clamp.

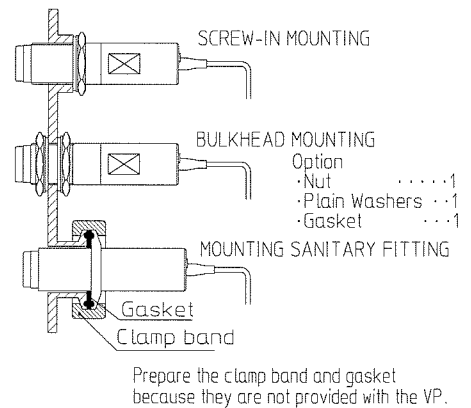

- (4) Install the sensor vertically or in an upward direction. Make sure the solid does not drop and/or accumulate on the vibration diaphragm.

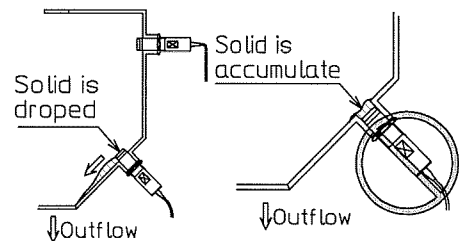

*: See section 12 for the word explanation.

7. WIRING

7.1 PREPARATION

Turn off the power supply.

⚠ WARNING

1. To avoid personal injury, leakage current or short circuit, the power supply shall be always turned off while wiring.
2. The power shall be insulated from the transformer's primary side (Utility power). Otherwise, the ground fault may occur since the sensor is electrically connected to the earth.

⚠ CAUTION

The output rating of the VP is 100 mA DC Max. Do not exceed this rating. Connect the relay or protective circuits between the sensor and the load if necessary.

7.2 WIRING

7.2.1 See below for wiring. Pay attention to the wiring color. We recommend to use with our power relay unit, PR2100/2200. (Refer to 7.2.2)

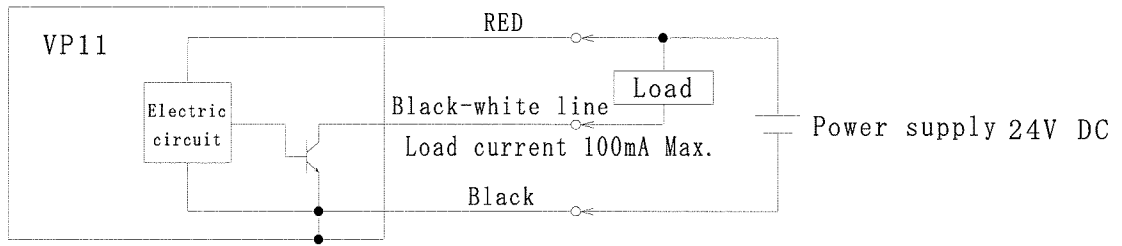

7.2.2 When connecting to our power relay unit, PR2100/2200, see as below.

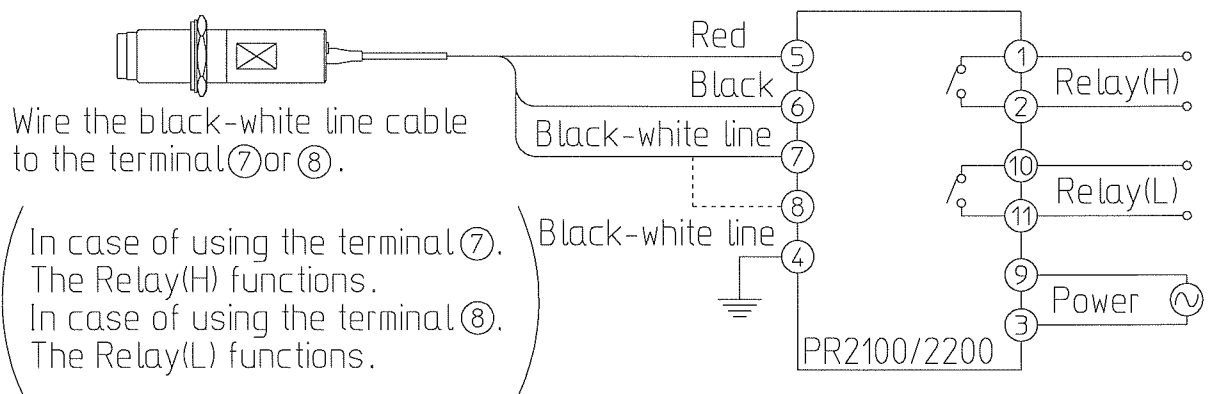

Realy 240V 3A AC Max. 30V 3A DC Max.	Power 90~132V AC (PR2100) 180~264V AC (PR2200)
--	--

8. ADJUSTMENT METHOD

- ① Check that the sensor is wired correctly. Then turn on the sensor.
- ② Remove the volume cap. Keep the volume cap in a safe place so that it will not be missing.
- ③ Turn the sensitivity adjuster counterclockwise until it stops.
- ④ Expose the vibration diaphragm to the sensing material so that the sensor will detect the sensing material.
- ⑤ With an elapse of a minimum of five seconds after the sensor is turned on, slowly turn the sensitivity adjuster clockwise until the red indicator turns on.
- ⑥ Slightly turn the sensitivity adjuster counterclockwise until both red and green indicators turn on, thus emitting orange light. Then the red indicator will be off with an elapse of approximately three seconds but the green indicator will keep turning on.
- ⑦ Slightly turn the sensitivity adjuster clockwise again until the red indicator is lit.
- ⑧ Isolate the vibration diaphragm from the sensing material so that the sensor will not detect them.
- ⑨ Check that both red and green indicators turn on, thus emitting orange light, and then the green indicator will keep turning on.
- ⑩ If neither orange nor green light is emitted, repeat the steps from ②.
- ⑪ Attach the volume caps securely so that the inside of the cap will be free of foreign substances.

Note: The sensitivity of the sensor increases with the sensitivity adjuster turned clockwise. When the adjuster is fully turned clockwise until it stops, the sensor will be always in the stage of detection. The sensitivity drops with the adjuster turned counterclockwise. In order to reduce the influence of sensing materials stuck on the vibration diaphragm, practically keep the sensitivity as low as possible while the sensor is in normal operation.

9. MAINTENANCE & INSPECTION

9. 1 REMOVING

9.1.1 Turn off the power supply.



WARNING

To avoid personal injury, the power supply shall be always turned off while wiring.

9.1.2 Disconnect an output cable.

9.1.3 Loosen the fixing nut and remove the sensor from the hopper.

9. 2 MAINTENANCE & INSPECTION

Inspect the sensor semi-annually or annually. Since inspection intervals varies with applications and process conditions such as pressure, temperature and so on, we recommend you to inspect periodically.

9.2.1 Remove adherence on the vibration diaphragm.

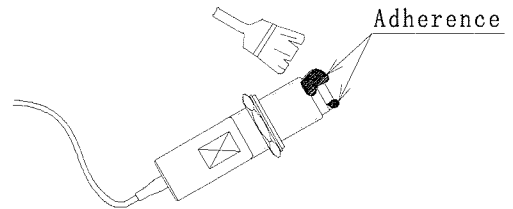

9.2.2 Refer to 7.2 WIRING, and wire the output cable tentatively.

9.2.3 Refer 8. ADJUSTMENT METHOD to check the operations.

9.2.4 Turn off the power and disconnect the tentative wiring.

9. 3 RE - INSTALLATION

Refer to 6.2 INSTALLATION.

9. 4 WIRING

Refer to 7.2 WIRING.

9. 5 ADJUSTMENT METHOD

Refer 8 ADJUSTMENT METHOD for the proper adjustment.

10. STORAGE

The sensor shall be stored under the following conditions when it is not used for a long time.

10. 1 Environmental conditions are as follows:

- The storing temperature range is -10°C to $+60^{\circ}\text{C}$.
- Relative humidity is 95% Max.
- No corrosive gases (such as NH_3 , SO_2 , Cl_2 , etc.).
- Vibration is low.

10. 2 Locate the sensor away from rain and splashing water.

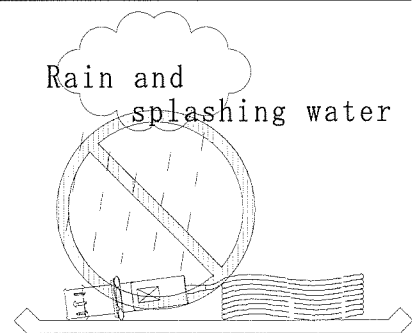

1 0 . 3 Remove adherence. Otherwise, it may cause malfunction when you use the next time.

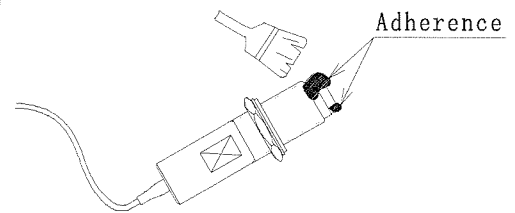

1 0 . 4 Do not put things on the sensor. It shall damage the body or nick the cable.

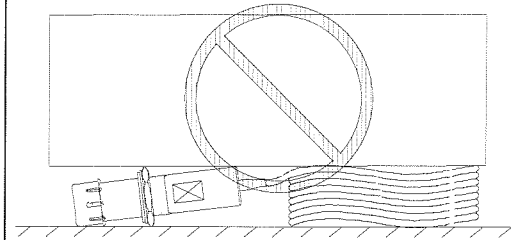

1 0 . 5 When storing, use protection cap or cushioning material to protect the vibration diaphragm.

REFERENCE

Keep the sensor in sealed plastic bags with desiccant or other moisture-proof packing. To prevent from scratch and/or dirt, put the sensor on rubber sheets or wood.

11. TROUBLESHOOTING

⚠ CAUTION

Use the following chart to troubleshoot the malfunctioning sensor.
If your remedies are unsuccessful, ask Nohken for repair and replacement.

NO SIGNAL OUTPUT WITH LEVEL CHANGE

- Material has bridge or angle of repose. ⇒ Install the sensor in good location.
- Flow of the solids. ⇒ Install the sensor in good location.
- Effected by heavy vibration. ⇒ Install the sensor in good location.
- Powder density is too small. ⇒ Powder density under 0.2 cannot be detected.

SIGNAL ALWAYS OUTPUTS WITHOUT LEVEL CHANGE

- Heavy deposit on the vibration diaphragm. ⇒ Clean it regularly.
- Material has dead stock. ⇒ Install the sensor in good location.

POWER · OPERATION LED DOES NOT LIGHT.

- Miswiring ⇒ Wire correctly. See section 7.
- Electrical contact is at fault due to overload. ⇒ Replace the sensor and check the load.
- Insufficient power supplied. ⇒ Make sure the power is 24V DC (18 to 30V DC).
- Cable is broken. ⇒ Replace the sensor.

If above remedies are unsuccessful, ask Nohken service department. Check and inform the nameplate model number and serial number.

12. GLOSSARY

- Vibration diaphragm : Detection part which generates vibration.
- Piezoelectric element: An element which occurs distortion by an application of the voltage. It vibrates the vibration diaphragm.
- NPN Open collector : NPN transistor used switch circuit.
- Angle of repose : The angle of maximum slope at which a heap of any loose solid material will stand without sliding.
- Dead stock : A space left in the cone of the hopper. Amount of dead stock varies with the angle of the cone.
- Bridge : An obstruction in the hopper to make a bridge by sticking powders.
- Vibrator : A vibrating device to shake and remove the build-up on the inner surface of the hopper.
- Knocker : A pneumatic device to knock and remove the build-up on the inner surface of the hopper.
- Sun shield : A shield or baffle to deflect the direct sunlight from the housing.

NOHKEN INC.

HEAD OFFICE : 15-29,Hiroshiba-cho,Suita-city,Osaka 564-0052,Japan.

TEL:06-6386-8141 FAX:06-6386-8140

TOKYO BRANCH OFFICE : 67,Kandasakumagashi,Chiyoda-ku,Tokyo 101-0026,Japan.

TEL:03-5835-3311 FAX:03-5835-3316

NAGOYA OFFICE : 3-10-17,Uchiyama,Chikusa-ku,Nagoya-city,Aichi 464-0075,Japan.

TEL:052-731-5751 FAX:052-731-5780

KYUSHU OFFICE : 14-1,2-chome,Asano,Kokurakita-ku,Kitakyushu-city,Fukuoka 802-0001,Japan.

TEL:093-521-9830 FAX:093-521-9834